



WOOD CEILING CATALOGUE

İçindekiler | Contents

Hakkımızda **02-03**

About Us

Deckowood **06-07**

Deckowood

Akustik Ahşap Asma Tavan Sistemleri **08-09**

Acoustic Wood Ceiling Systems

Lineer Ahşap Tavan Sistemleri **24-25**

Linear Wood Ceiling Systems

Aluminyum Borulu T-24 Taşıyıcı Sistem **30-31**

Linear Grillwood With T-24 Systems

Hook-on Taşıyıcı Sistem **34-35**

Hook-on Systems

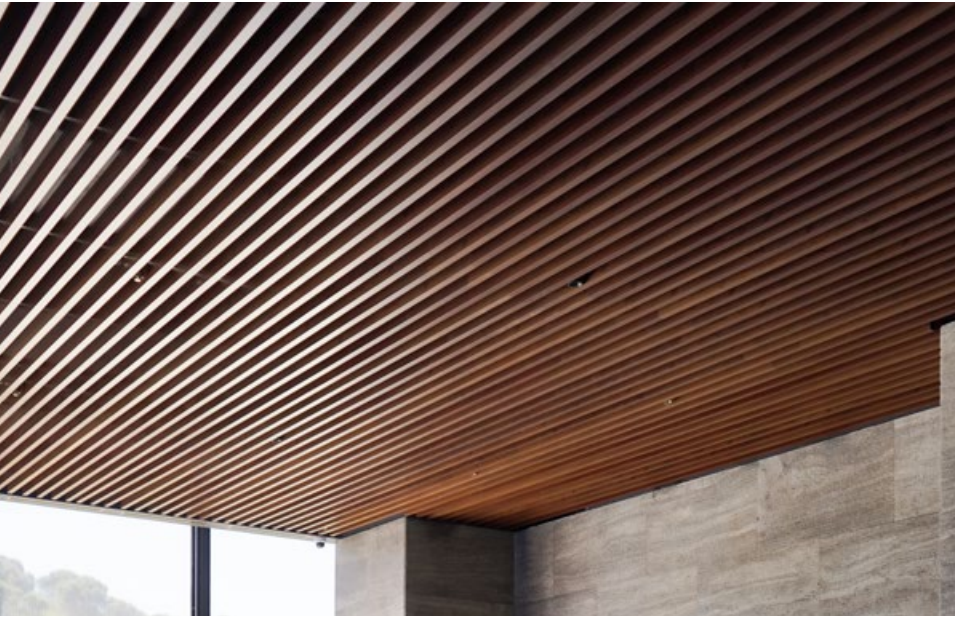



Dinamik yapılanmasıyla sürekli olarak büyüyen Deckon, kurulduğu günden beri fiyat ve performans prensibiyle asma tavan sektöründe pazar payını hızlı bir biçimde büyüterek sektörünün en büyük firmalarından biri haline gelmiştir. Bunun yanı sıra hem yurtiçi hem yurtdışında pek çok projeyi de başarıyla tamamlamıştır.

Firmamız en küçük projeden en büyük veya uzmanlık gerektiren özel projelere kadar geniş bir segmentte tavan çözümleri ve teknik çözüm ortaklığı sunmaktadır.

Ürün ve hizmet alanlarının bir parçası olarak kendi üretimi olan Deckon Premium ve Deckofix markası altında sırasıyla asma tavan panelleri ve taşıyıcı sistemleri yapabilmektedir. Ayrıca Rockfon, USG, AMF gibi alanında uzman asma tavan firmalarının Türkiye distribütörlüğü ile her tür proje ve müşteri talebine uygun ürün ve hizmet sunarak, en basit veya en sofistike projelerde çözüm ortaklığı yapabilmektedir.

Since its establishment, Deckon, continuously growing with its dynamic structure, has become one of the largest companies in the suspended ceiling sector by rapidly increasing its market share with the principle of price and performance. Additionally, the company has successfully completed numerous projects both domestically and internationally.

Our company provides ceiling solutions and technical partnership in a wide range of segments, from the smallest to the largest projects, including those requiring expertise.

As part of its product and service offerings, the company is able to produce suspended ceiling panels and supporting systems under its own Deckon Premium and Deckofix brands, respectively. In addition, through its distribution partnerships with specialized companies such as Rockfon, USG, and AMF the company is able to provide products and services that meet the needs of any project and customer demand. With this, the company is capable of providing solutions for both simple and sophisticated projects.

Ahşap Asma Tavan Sistemleri

Wood Ceilings Systems





deckowood®

Deckowood® ahşabın sıcaklığını, akustik konforla birleştiren, tavan ve duvarlarda dekoratif tasarım olanakları sağlayan paneller serisidir. Paneller düşük formaldehid içerkli mdfden üretilmekte ve farklı tipte doğal ahşap kaplama seçenekleriyle sunulmaktadır.

Deckowood® panels are produced in MDF (Medium density fiberboard) with a low formaldehyde content and offers warm wood appearance on ceilings and walls which provides acoustic comfort available in many different natural wood essence veneers.

Akustik ahşap paneller, ofis, showroom ve lobi alanlarında doğal bir görünüm sunmaktadır. Delikli ahşap paneller, farklı perforasyon tipleriyle orta ya da yüksek seviyede ses yutuculuk performansı sağlayan ve akustik projelendirmelerde sık kullanılan dekoratif ürünlerdir. Özellikle alanın tamamının yüksek derecede ses yutucu panellerle kaplanamadığı yerlerde düşük oranda perforasyonlu ürünlerle ses yansıtıcı paneller olarak da işlev görmektedirler.

Wooden panels offer natural look for the lobbies and office areas. Offering medium or high level of sound absorption with various perforation types, perforated wood panels are used with exclusive acoustic projects. Especially used as sound reflecting panels for the spaces like conference halls, theatres where high-sound absorbing panels can not be installed all around the spaces.

Deckowood Modüler

Modular



Panel Tipi Panel Type	MDF Lam, MDF üzeri doğal kaplama, MDF üzeri lake boya	Melamine laminated MDF, Veneer MDF, Lacquered Paint MDF
Panel Ebat Panel Size	600 mm x 600 mm 600 mm x 1200 mm 517 mm x 1381 mm (Duvar)	600 mm x 600 mm 600 mm x 1200 mm 517 mm x 1381 mm (Wall)
Panel Kalınlığı Panel Thickness	8 - 10 - 12 - 18 mm	8 - 10 - 12 - 18 mm
Taşıyıcı Sistem Grid System	T24 - T15 - Fugalı T15 Lamba zivana	T24 - T15 - T15 Ultraline Tongue and groove joint
Perforasyon Perforation	Ø3mm - Ø4mm - Ø6mm - Ø8mm - Ø10mm 2 - 3 - 4 mm çizgili ön yüz Ø 8 mm - Ø 10 mm delikli arka yüz	Ø3mm - Ø4mm - Ø6mm - Ø8mm - Ø10mm 2 - 3 - 4 mm slotted front side Ø 8 mm - Ø 10 mm perforated back side
Akustik Kumaş Acoustic Felt	Std, Soundtex, Nonvowen akustik ve yanmaz kumaş seçenekleri	Std, Soundtex, Nonvowen inflammable acoustic fleece options
Kalite Belgeleri Certifications	TSE, CE	TSE, CE

Akustik Ahşap Asma Tavan Sistemleri

Acoustic Wood Ceiling Systems

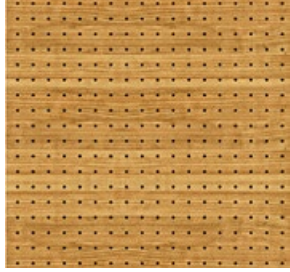

P1

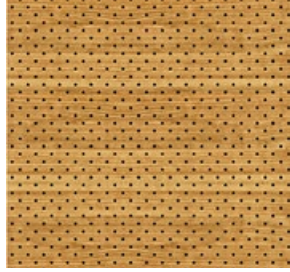

P2

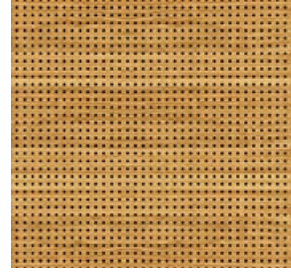

P3

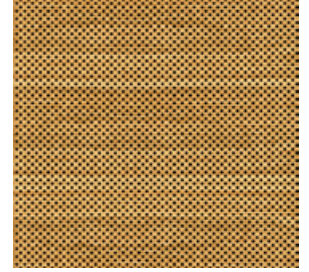

P4



L0



L1



L2



L3

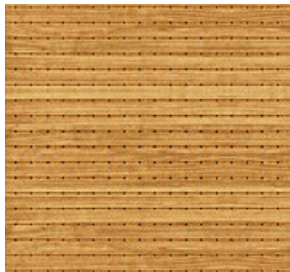

P1L1

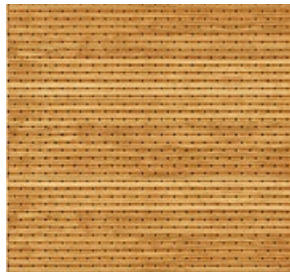

P2L2

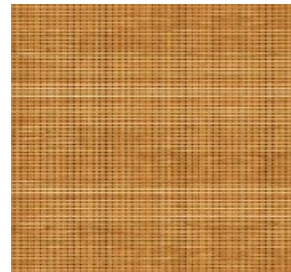

P3L2



P4L3

P1

Perforasyon Delik Çapı <i>Perforation hole dia</i>	Ø 8 mm
Delikler Arası Mesafe <i>Hole distance c/c</i>	32x32 mm
Panel Ölçüsü <i>Panel dimension</i>	600x600 mm
Delik Sayısı / Panel <i>Holes per panel</i>	324
Delik Sayısı m2 <i>Holes per m2</i>	900
Perforeli Alan % <i>Perforated area %</i>	4,52%
Ağırlık / Panel <i>Weight / Panel</i>	4,11 kg
Ağırlık / m2 <i>Weight / m2</i>	11,40 kg

P2

Perforasyon Delik Çapı <i>Perforation hole dia</i>	Ø 8 mm
Delikler Arası Mesafe <i>Hole distance c/c</i>	32x16 mm
Panel Ölçüsü <i>Panel dimension</i>	600x600 mm
Delik Sayısı / Panel <i>Holes per panel</i>	648
Delik Sayısı m2 <i>Holes per m2</i>	1800
Perforeli Alan % <i>Perforated area %</i>	9,04%
Ağırlık / Panel <i>Weight / Panel</i>	3,91 kg
Ağırlık / m2 <i>Weight / m2</i>	10,86 kg

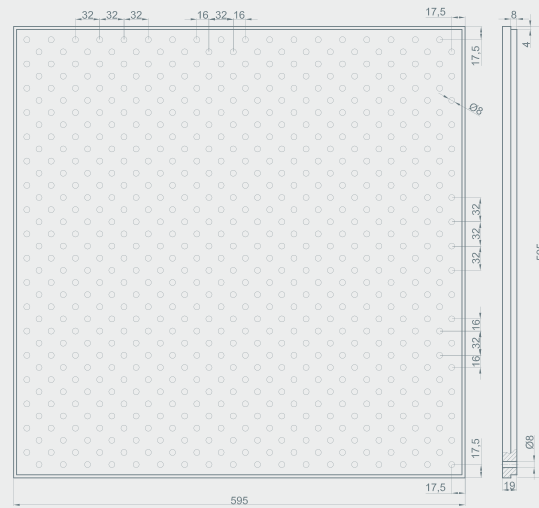
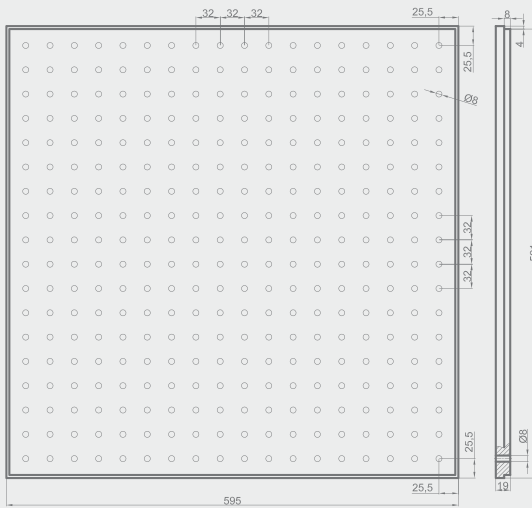

P3

Perforasyon Delik Çapı <i>Perforation hole dia</i>	Ø 8 mm
Delikler Arası Mesafe <i>Hole distance c/c</i>	16x16 mm
Panel Ölçüsü <i>Panel dimension</i>	600x600 mm
Delik Sayısı / Panel <i>Holes per panel</i>	1296
Delik Sayısı m2 <i>Holes per m2</i>	3600
Perforeli Alan % <i>Perforated area %</i>	18,09 %
Ağırlık / Panel <i>Weight / Panel</i>	3,52 kg
Ağırlık / m2 <i>Weight / m2</i>	9,78 kg

P4

Perforasyon Delik Çapı <i>Perforation hole dia</i>	Ø 8 mm
Delikler Arası Mesafe <i>Hole distance c/c</i>	16x8 mm
Panel Ölçüsü <i>Panel dimension</i>	600x600 mm
Delik Sayısı / Panel <i>Holes per panel</i>	2592
Delik Sayısı m2 <i>Holes per m2</i>	7200
Perforeli Alan % <i>Perforated area %</i>	36,17 %
Ağırlık / Panel <i>Weight / Panel</i>	2,74 %
Ağırlık / m2 <i>Weight / m2</i>	7,62 kg

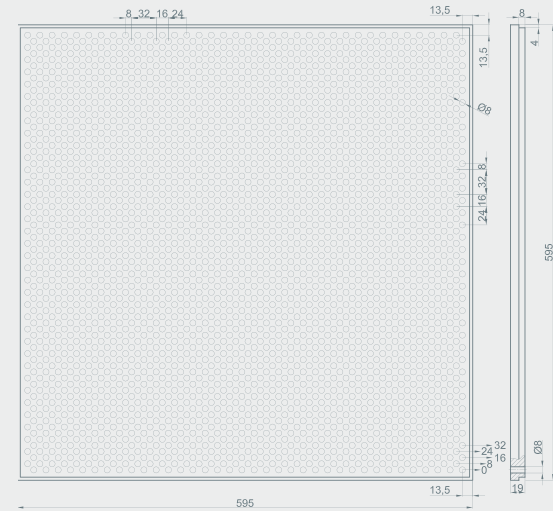
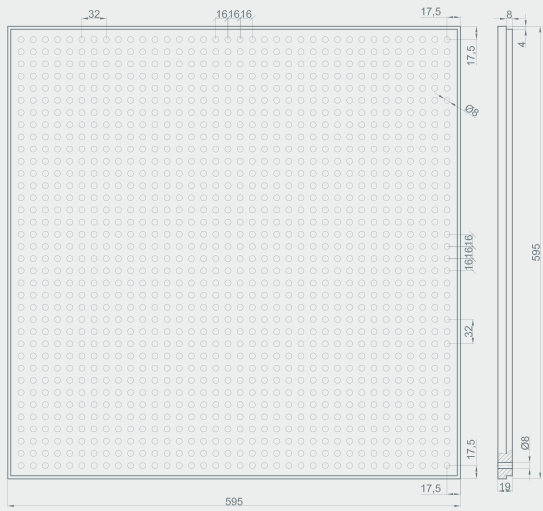

P1L1

Perforasyon Delik Çapı <i>Perforation hole dia</i>	Ø 8 mm
Delikler Arası Mesafe <i>Hole distance c/c</i>	32x32 mm
Derz Ölçüsü ve Sayısı <i>Slot size and no</i>	4x6 mm / 18
Derzler Arası Mesafe <i>Slot distance c / c</i>	32 mm
Panel Ölçüsü <i>Panel dimension</i>	600x600 mm
Delik Sayısı / Panel <i>Holes per panel</i>	324
Delik Sayısı / m2 <i>Holes per m2</i>	900
Perforeli Alan % <i>Perforated area %</i>	4,64 %
Ağırlık / Panel <i>Weight / Panel</i>	4,10 kg
Ağırlık / m2 <i>Weight / m2</i>	11,39 kg

P2L2

Perforasyon Delik Çapı <i>Perforation hole dia</i>	Ø 8 mm
Delikler Arası Mesafe <i>Hole distance c/c</i>	32x16mm
Derz Ölçüsü ve Sayısı <i>Slot size and no</i>	4x6 mm / 36
Derzler Arası Mesafe <i>Slot distance c / c</i>	16 mm
Panel Ölçüsü <i>Panel dimension</i>	600x600 mm
Delik Sayısı / Panel <i>Holes per panel</i>	648
Delik Sayısı / m2 <i>Holes per m2</i>	1800
Perforeli Alan % <i>Perforated area %</i>	9,28 %
Ağırlık / Panel <i>Weight / Panel</i>	3,90 kg
Ağırlık / m2 <i>Weight / m2</i>	10,84 kg

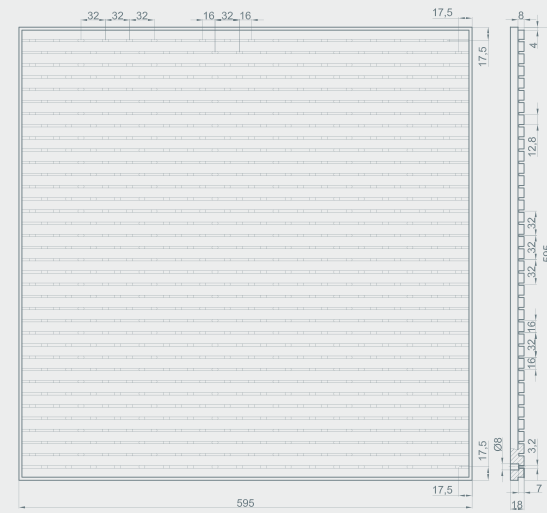
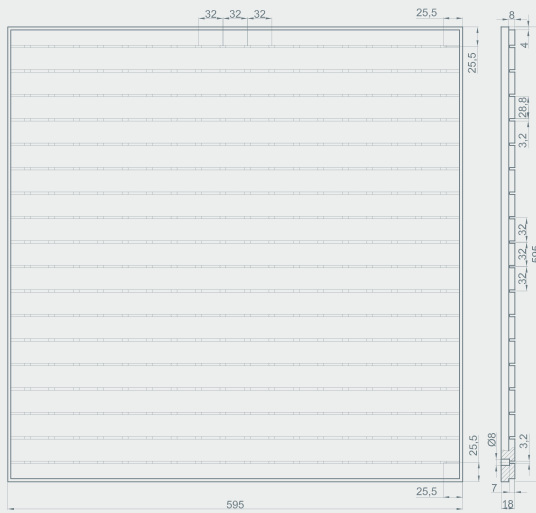

P3L2

Perforasyon Delik Çapı <i>Perforation hole dia</i>	Ø 8 mm
Delikler Arası Mesafe <i>Hole distance c/c</i>	16x16 mm
Derz Ölçüsü ve Sayısı <i>Slot size and no</i>	4x6 mm / 36
Derzler Arası Mesafe <i>Slot distance c / c</i>	16 mm
Panel Ölçüsü <i>Panel dimension</i>	600x600 mm
Delik Sayısı / Panel <i>Holes per panel</i>	1296
Delik Sayısı / m2 <i>Holes per m2</i>	3600
Perforeli Alan % <i>Perforated area %</i>	18,33 %
Ağırlık / Panel <i>Weight / Panel</i>	3,51 kg
Ağırlık / m2 <i>Weight / m2</i>	9,76 kg

P4L3

Perforasyon Delik Çapı <i>Perforation hole dia</i>	Ø 8 mm
Delikler Arası Mesafe <i>Hole distance c/c</i>	16x8 mm
Derz Ölçüsü ve Sayısı <i>Slot size and no</i>	4x6 mm / 72
Derzler Arası Mesafe <i>Slot distance c / c</i>	8 mm
Panel Ölçüsü <i>Panel dimension</i>	600x600 mm
Delik Sayısı / Panel <i>Holes per panel</i>	2592
Delik Sayısı / m2 <i>Holes per m2</i>	7200
Perforeli Alan % <i>Perforated area %</i>	36,66 %
Ağırlık / Panel <i>Weight / Panel</i>	2,72 kg
Ağırlık / m2 <i>Weight / m2</i>	7,57 kg



Project: CPM Office | Location: İstanbul
Products used: Linear wood ceiling systems

Akustik Ahşap Asma Tavan Sistemleri

Acoustic Wood Ceiling Systems

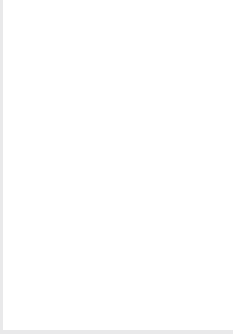

Opak Beyaz
White



Akça
Birch



Carmen

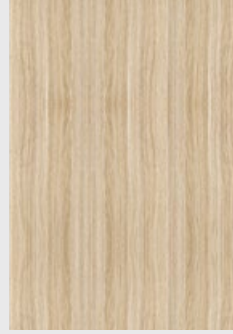

Naturel Meşe
Naturel Oak



Karya



Marbella Kiraz
Marbella Cherry



Samba



Sahara



Bambu
Bamboo

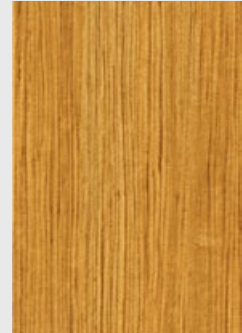

Afrika Ceviz
African Walnut



Milas



Teak



Elma
Apple



Atlantis

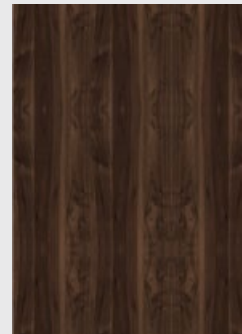

Metalik Ceviz
Metallic Walnut



Project: British-Georgian Academy | Location: Georgia
Products used: Wood ceiling systems & Acoustic wood wall panels





Project: British-Georgian Academy | Location: Georgia
Products used: Wood ceiling systems & Acoustic wood wall panels



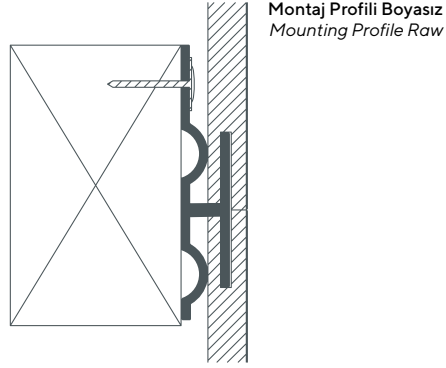

Montaj Profili Boyasız
Mounting Profile Raw

DECKON - ADP01

Deckowood Duvar Montaj Profilleri

Wall Mounting Profiles

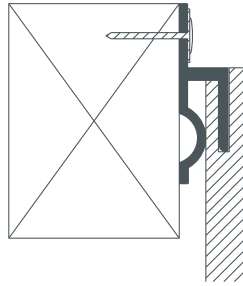

Bitiş Profili Boyalı
Finishing Profile Painted

DECKON - ABIP04

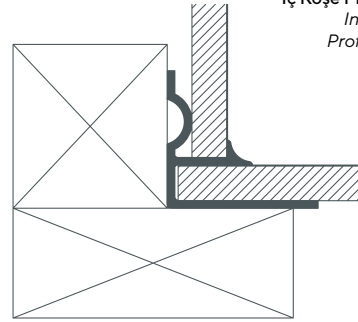

İç Köşe Profili Boyalı
Inner Corner
Profile Painted

DECKON - AIKP18

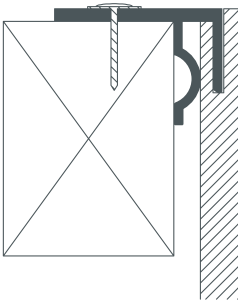

Yan Bitiş Profili Boyasız
Side Finishing Profile Raw

DECKON - ABIP05

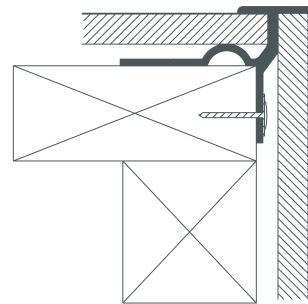

Dış Köşe Profili Boyalı
Outer Corner
Profile Painted

DECKON - ADKP19

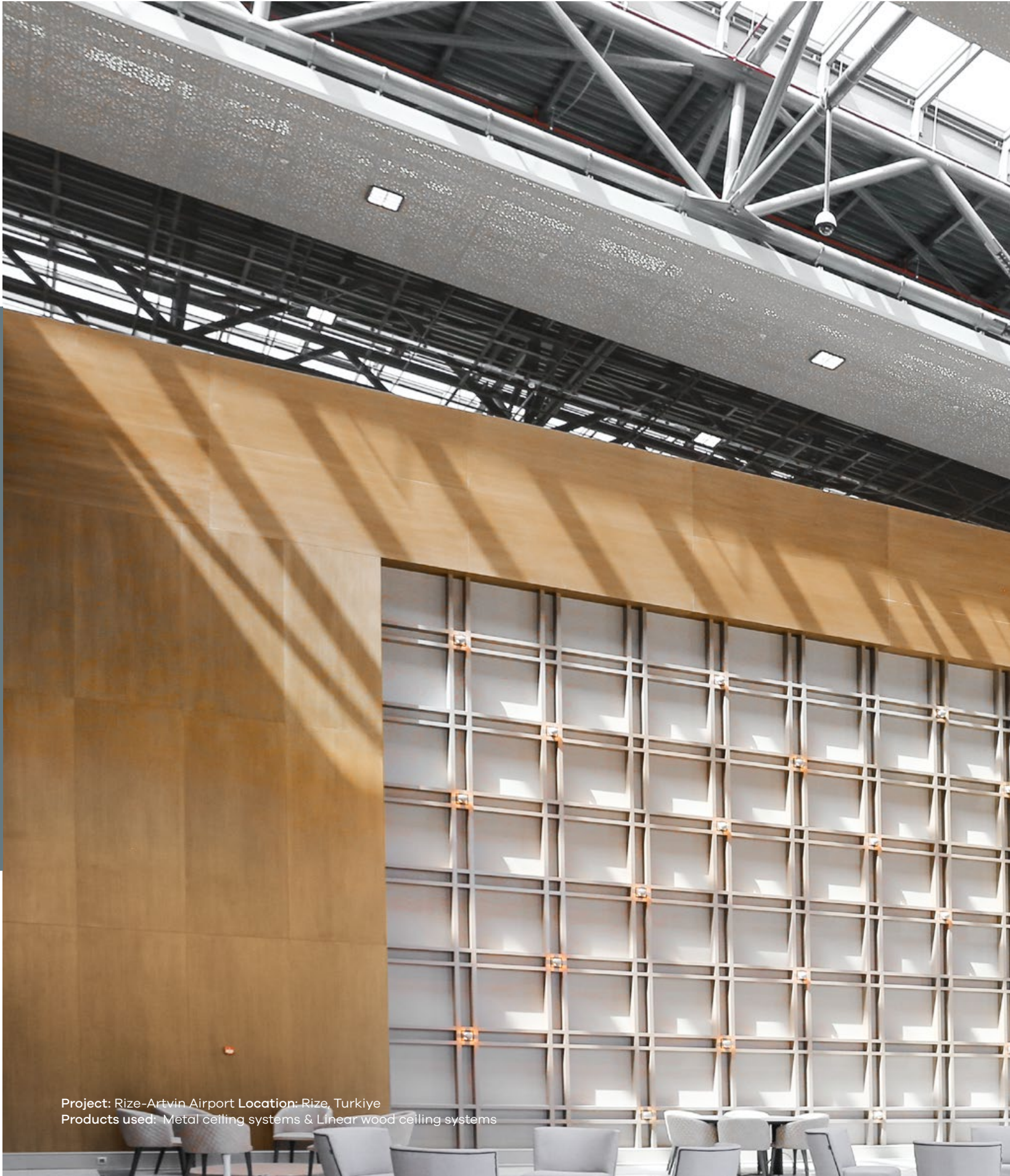

Project: Rize-Artvin Airport Location: Rize, Turkiye
Products used: Metal ceiling systems & Linear wood ceiling systems



 deckowood[®]

Akustik Ahşap Asma Tavan Sistemleri

Acoustic Wood Ceiling Systems



Deckowood Masif ahşap, modern tasarım ile buluşuyor. Masif lineer ahşap paneller ile tavanlarınıza estetik katın.
Deckowood Massive solid wood meets with modern design. Add some aesthetics to your ceilings with DeckoWood.

Deckon'dan inovatif projeler için yenilikçi ürünler. Innovative Products for Innovative Projects.

Lineer ahşap tavan sistemi, mdf-lam dan kesilmiş çıtaların veya masif ağaç çıtaların yanyana istenen aralıklarla dizilmesi ve bir modül haline getirilmesi ile ardından da istenilen taşıyıcı sisteme entegre edilerek sökülüp takılmasına imkan sağlanarak oluşturulan son derece dekoratif bir tavan sistemidir. Kullanılan malzemelerin kesim ve işleme kolaylığı, en, yükseklik ve boy ölçülerinin istenildiği şekilde olabilmesi, tasarımcılara oldukça geniş olanaklar sunmaktadır. Izgara biçiminde lineer ahşap görüntüsü, hem estetik kaygılara hem de ortamın hava sirkülasyonuna katkı sağlamaktadır.

Linear wooden ceiling system is an extremely decorative ceiling system formed by aligning mdf board slats or solid wood slats with desired intervals and then being integrated to desired carrier system in a manner to enable it being mounted and demounted. Ease of cutting and processing of materials used, the width, height and length being at desired dimensions offers the designers vast possibilities. Linear wooden look in shape of a grid contributes both to aesthetic concerns and the circulation of ambient air.

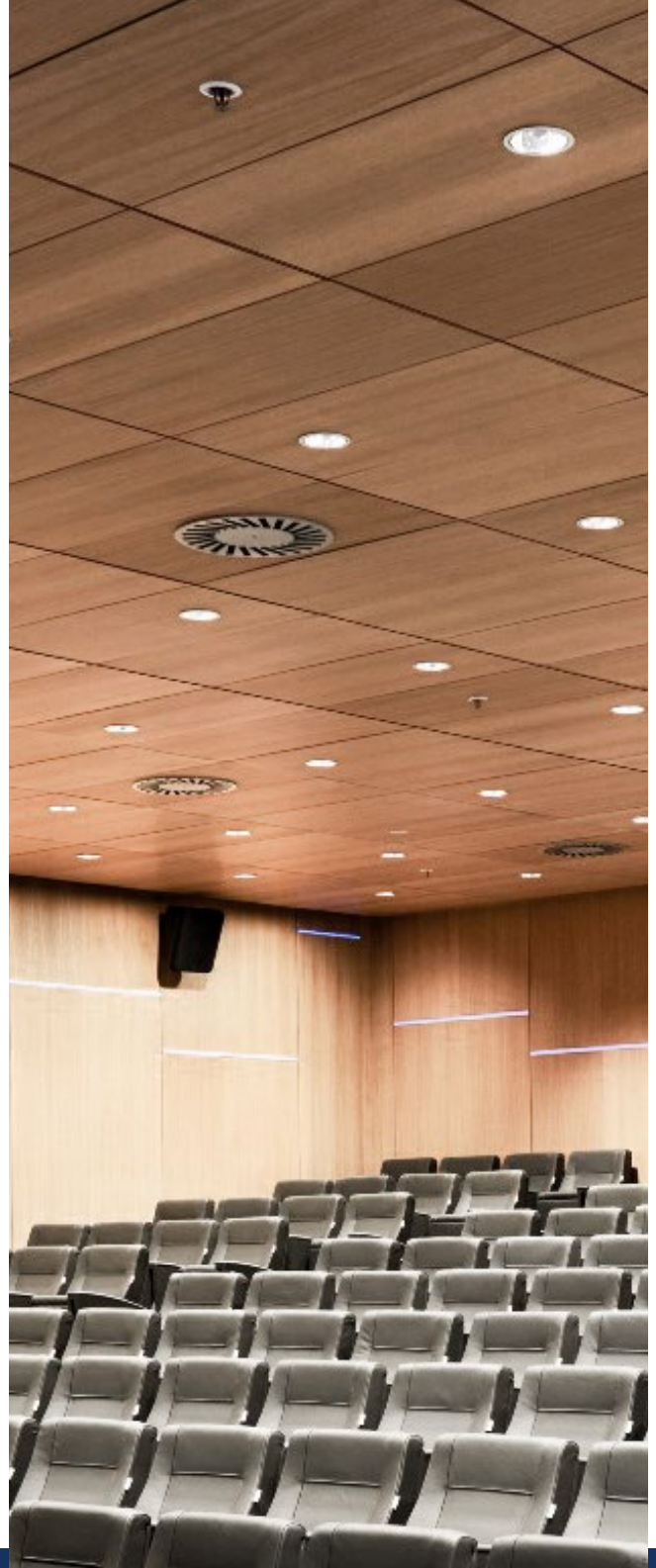

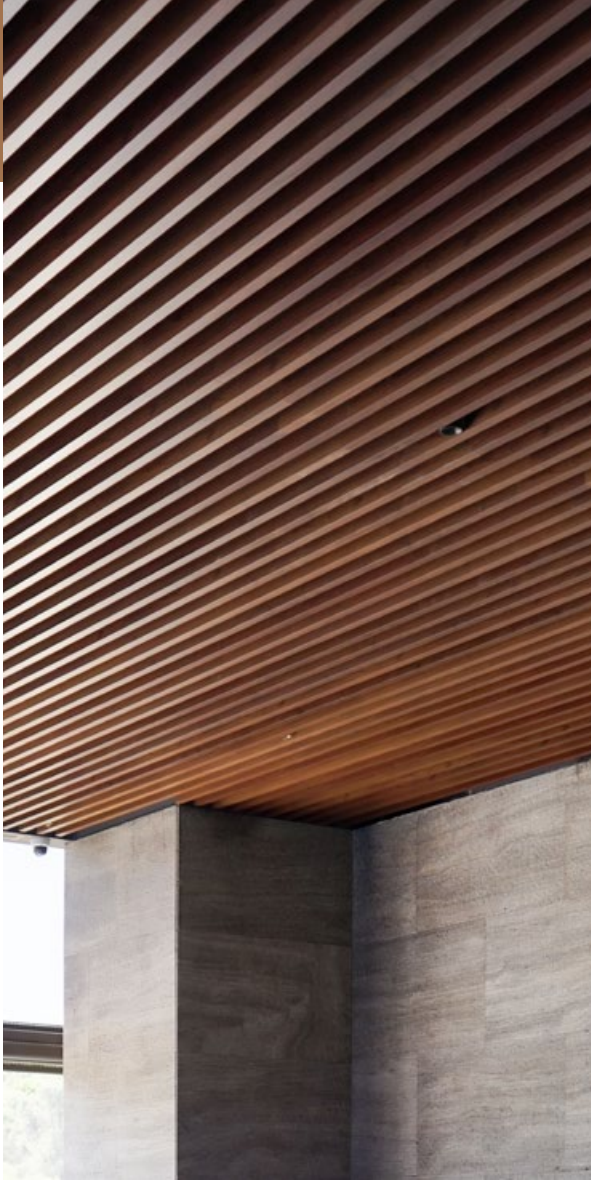

Deckowood Akustik Lineer Ahşap Sistem *Deckowood Acoustic Linear Wood System*

MONTAJ

Çıtalar, birbirine içlerinden geçen alüminyum boru ile bağlıdırlar. Bu borular da bir klips vasıtasıyla modülleri taşımak üzere ana taşıyıcı profile bağlanırlar. İstenilen sayıda çıta bir modül oluşturur ve bu modül taşıyıcıya bağlı bulunan klips sayesinde istenildiği zaman sökülüp takılabilir. Çıtalar da uç uca basit bir ekleme aparatıyla birbirlerine eklenirler.

MONTAGE

Slats are joined each other with traverse aluminium pipes. And such pipes are connected to the main carries to carry the modules by means of clips. Slats with desired number forms a module and this module can be demounted and mounted when desired by means of a clip attached to the carries.



deckowood.

Project: Fileto Restaurant Location: Istanbul, Türkiye
Products used: Linear wood ceiling systems







Project: Rize-Artvin Airport Location: Rize, Turkiye
Products used: Metal ceiling systems & Linear wood ceiling systems



Linear Ahşap Baffle Tavan Sistemleri

Linear Wood Baffle
Ceiling Systems

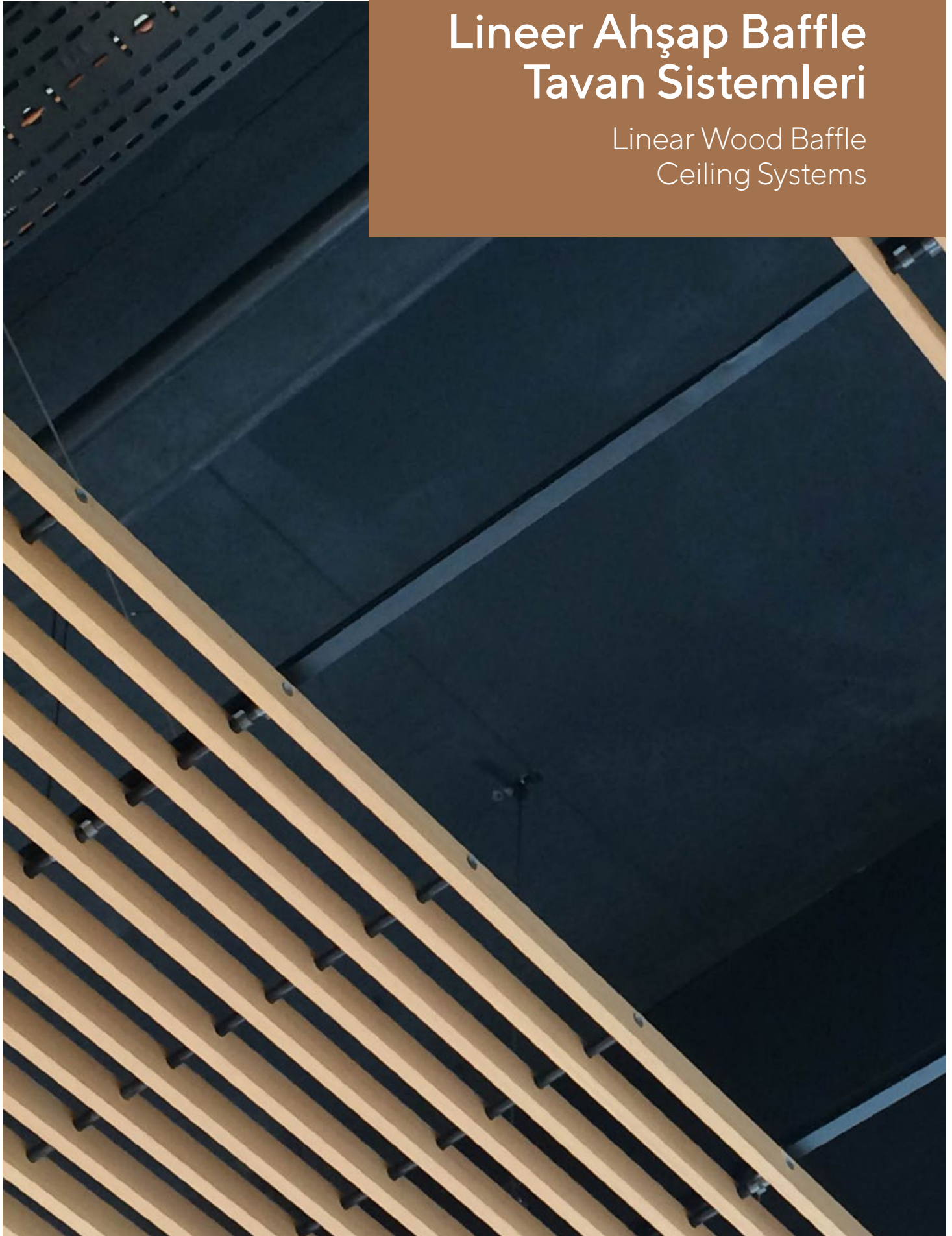

Lineer Ahşap Baffle Asma Tavan Sistemi

Linear Wood Baffle Ceiling System

Modül 138 *Module 138*

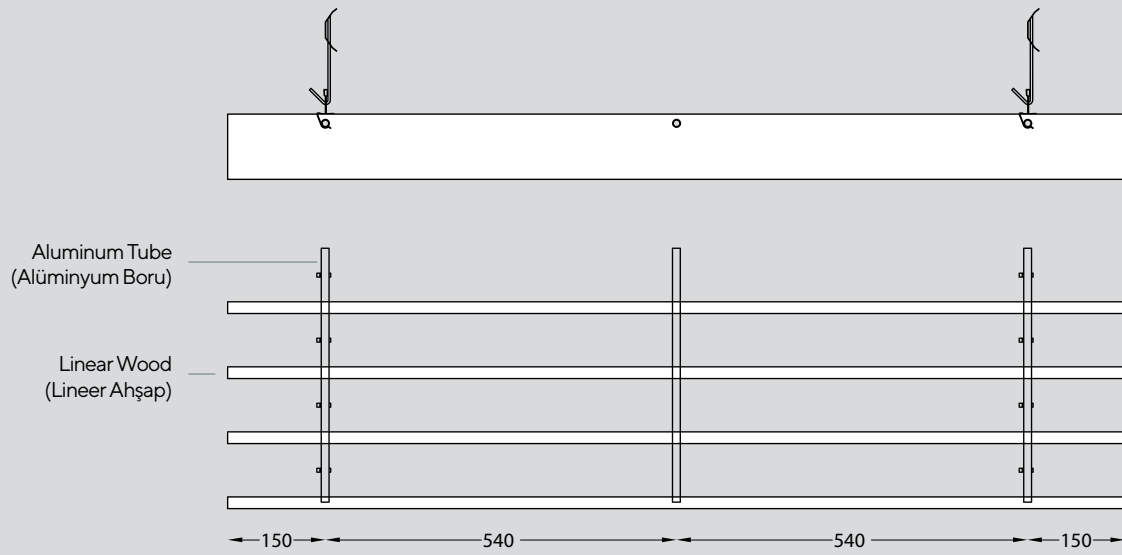

Modül 192 *Module 192*

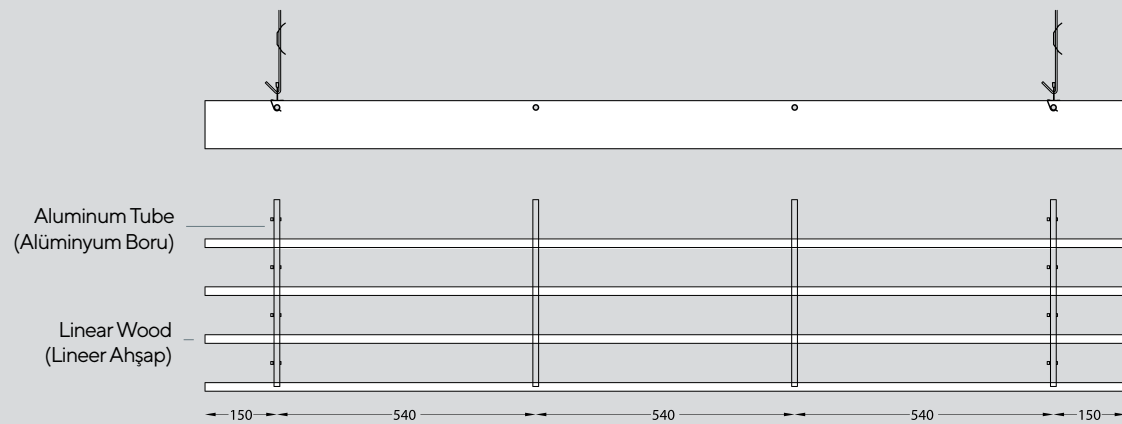



Project: Vadi İstanbul Radisson Blue Hotel Location: İstanbul, Türkiye
Products used: Linear wood ceiling systems



 deckowood®

Aluminyum Borulu T-24 Taşıyıcı Sistem

Linear Grillwood
With T-24 System

Project: Türk Telekom Head Office Location: İstanbul, Türkiye
Products used: Linear wood ceiling systems



deckowood.

Aluminyum Borulu T-24 Taşıyıcı Sistem Linear Grillwood With T-24 System

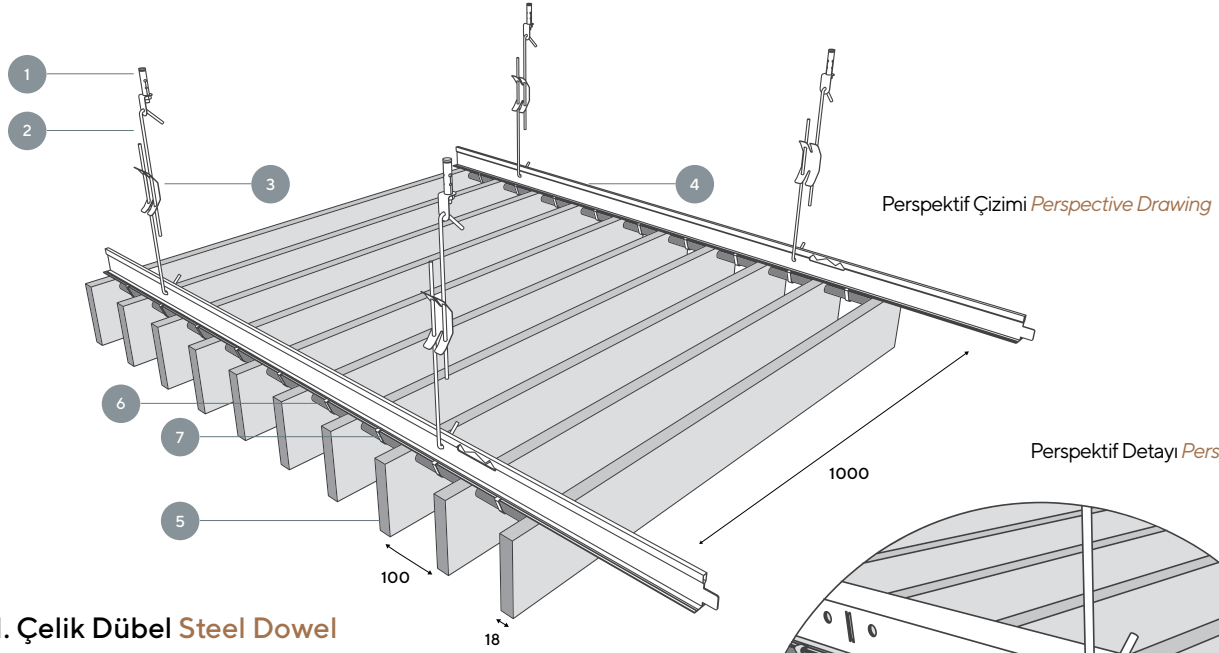

Perspektif Detayı Perspective Detail

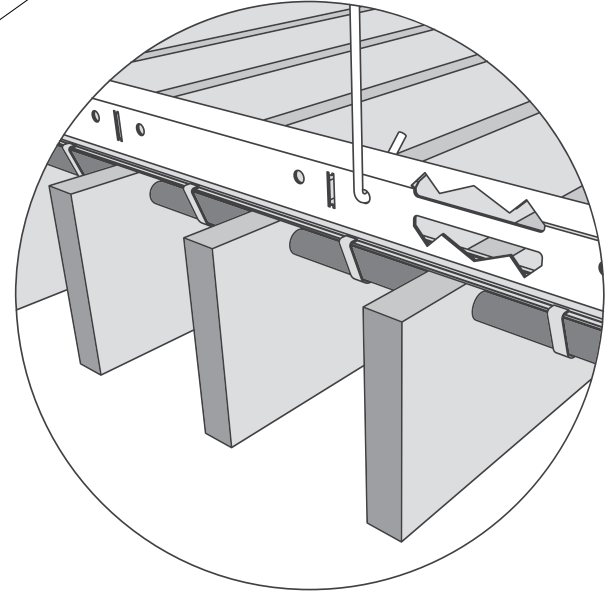

1. Çelik Dübel Steel Dowel
2. Askı Teli Hanger Wire
3. Çiftli Yay Double Spring
4. T24 Taşıyıcı T24 Tee
5. Ahşap Baffle Grill Baffle
6. Aluminyum Boru Aluminum Tube
7. Birleşim Klipsi Clips

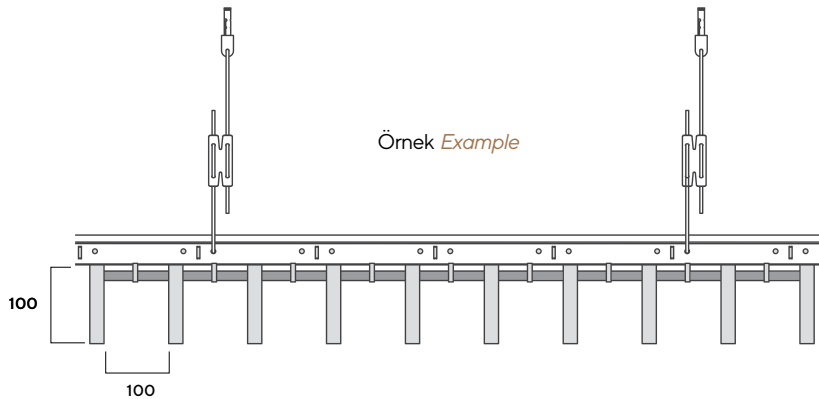

Teknik Bilgiler *Technical Info:*

Ürün • *Product*

Aluminyum Borulu T24 Taşıyıcılı Lineer Ahşap Asma Tavan
Wood Linear Suspended Ceiling System

Ebatlar • *Sizes*

18x100-120mm, boylar: imalat çizimine göre
18x100mm lengths: according to shop drawing

Taşıyıcı Sistem • *Suspension System*

T24 (24x38mm) ana taşıyıcı galvaniz çelik profillerden oluşur.
T-24 (24x38 mm) main runner made of galvanized steel

Özellikler • *Specification*

c/c: 100mm akstan aksa uzaklık
c/c: 100mm center to center distance

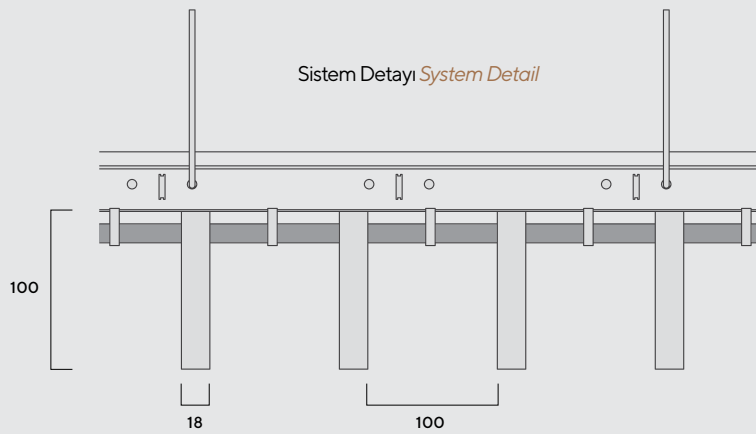

Kesit *Section*

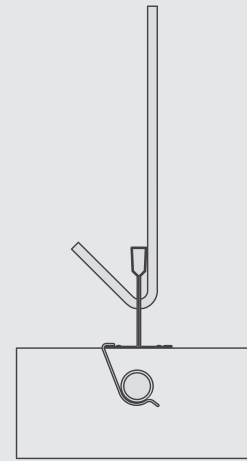



Project: Türk Telekom Head Office Location: İstanbul, Türkiye
Products used: Linear wood ceiling systems



deckowood

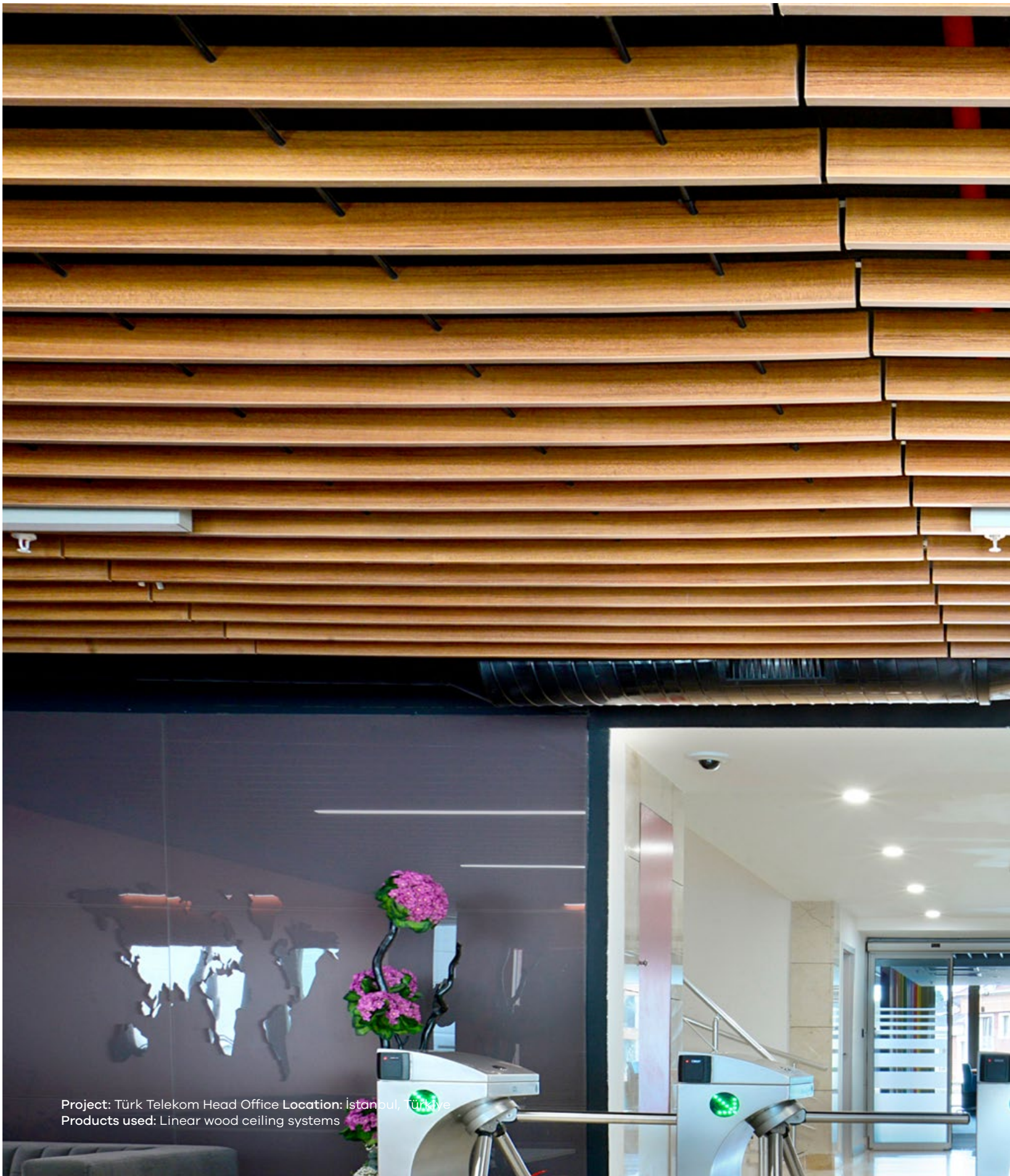

Project: Türk Telekom Head Office Location: İstanbul, Türkiye
Products used: Linear wood ceiling systems



deckowood®

Hook-on Taşıyıcılı Sistem Hook-on System

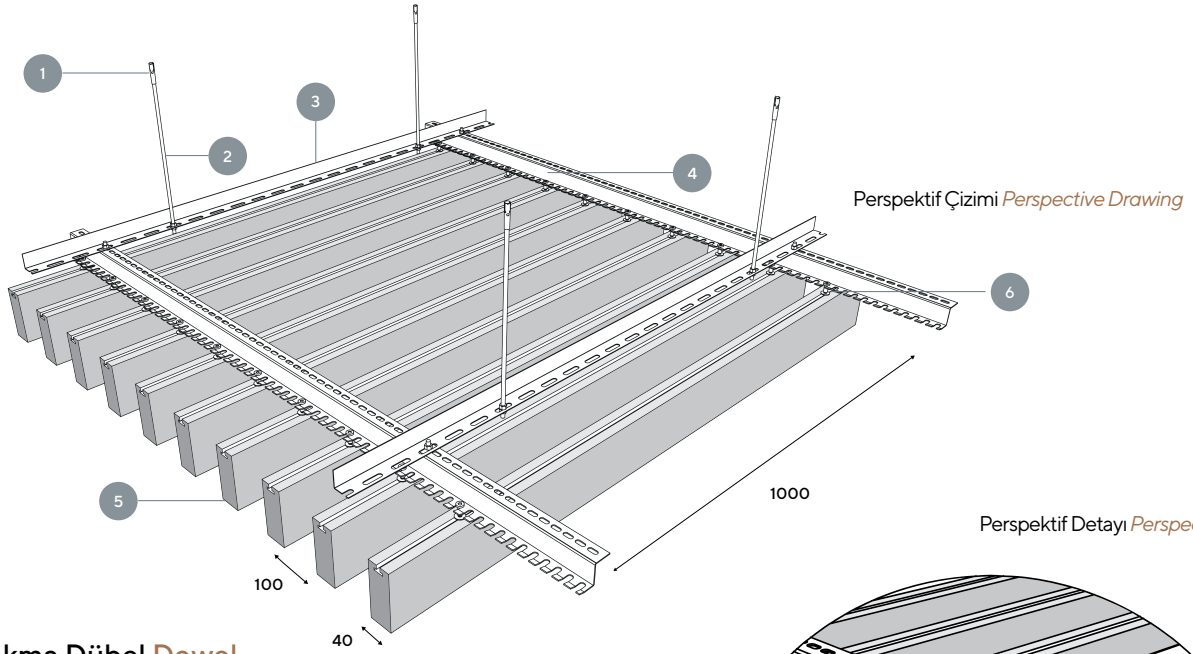

Perspektif Detayı *Perspective Detail*

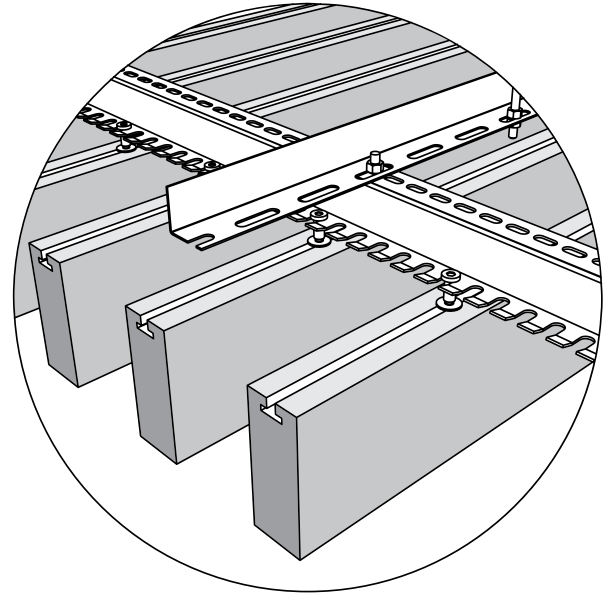

1. Çakma Dübel *Dowel*
2. Tij *Threaded Rod*
3. Ana Taşıyıcı L Profili *Main Tee*
4. Z Taşıyıcı *Z Profile*
5. Ahşap Baffle *Wood Baffle*
6. Bağlantı Klipsi *Clips*

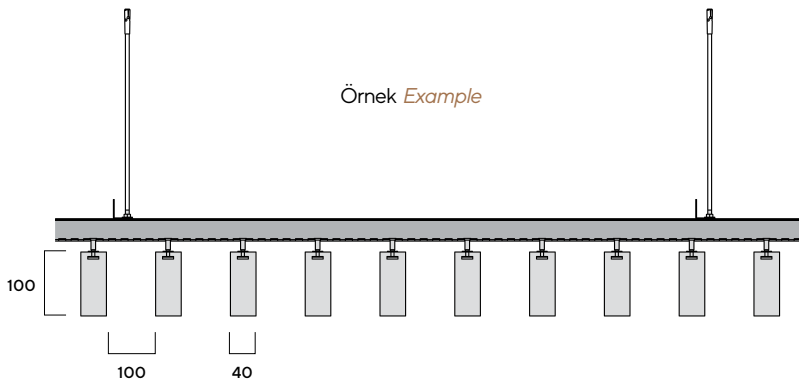

Teknik Bilgiler *Technical Info:*

Ürün • *Product*

Hook-on Lineer Ahşap Asma Tavan

Hook-on Wood Linear Suspended Ceiling System

Ebatlar • *Sizes*

18x100-120mm, boylar: imalat çizimine göre

18x100-120mm lengths : according to shop drawing

Taşıyıcı Sistem • *Suspension System*

Hook-on sistem slotlu Z (20x40x20x1mm)

ve L (25x25x1mm) galvaniz çelik ana taşıyıcılardan oluşur.

*Hook-on system made of main runner Z (20x40x20x1mm)
main runner (25x25x1mm) galvanized steel with slots and
holes.*

Özellikler • *Specification*

c/c: 100mm akstan aksa uzaklık

c/c: 100mm center to center distance

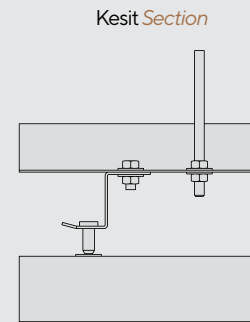
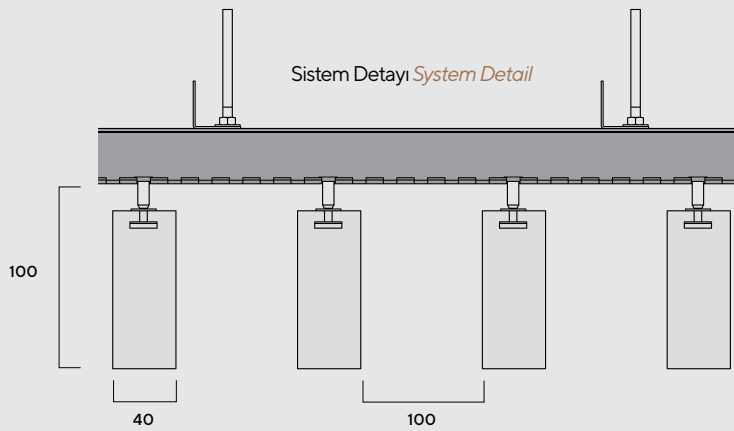



Project: Bahrain International Airport | Location: Bahrain
Products used: Metal ceiling systems & Linear metal ceiling systems

 deckowood®





Project: Rize-Artvin Airport **Location:** Rize, Turkiye
Products used: Metal ceiling systems & Linear wood ceiling systems



deckowood.



Merkez / Head Office

Ferhatpaşa Mahallesi

Akdal Sokak No:5

Ataşehir - İstanbul - Türkiye

T: +90 216 314 24 22 - 33

T: +90 216 415 18 93 - 94

F: +90 216 314 24 11

T: +90 216 415 18 95

Fabrika / Factory

Kayseri OSB 12. Cad. No:31/A

Melikgazi - Kayseri - Türkiye

T: +90 352 290 72 02 - 03

F: +90 352 290 14 99

Akdeniz Bölge. Müd. / Branch Office

Bakliyatçılar Sitesi

Mersin-Adana Karayolu Üzeri 6. km

Karaduvar Kavşağı C Blok No:3

Mersin - Türkiye

T: +90 324 221 96 13

F: +90 324 221 96 11

Ege Bölge. Müd. / Branch Office

Karacaoğlan Mahallesi

6165 Sokak A Blok No: 8 C

Bornova - Işıkent / İzmir - Türkiye

T: +90 232 472 02 20

F: +90 232 472 02 76



deckon.com.tr